

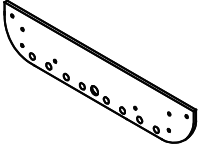

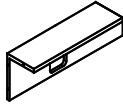

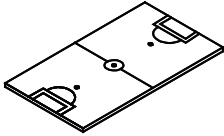

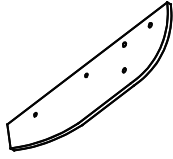

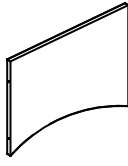



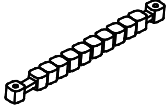



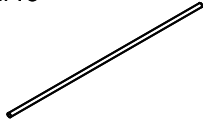





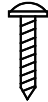
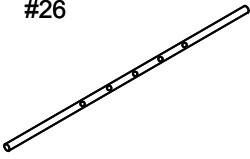
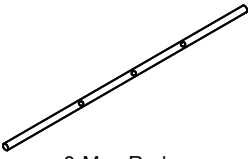
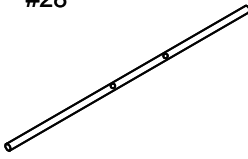

# Part List

<p>#1</p>  <p>Long-side Boards 2PCS</p>	<p>#2</p>  <p>Short-side Boards 2PCS</p>	<p>#3</p>  <p>Playfield 1PC</p>	<p>#4</p>  <p>Legs 4PCS</p>	<p>#5</p>  <p>Leg Panels 2PCS</p>
<p>#6</p>  <p>Connection plate 2PCS</p>	<p>#7</p>  <p>Nuts 12PCS</p>	<p>#8</p>  <p>1/4*2-3/4" Bolts 12PCS</p>	<p>#9</p>  <p>1/4*16mm Washers 12PCS</p>	<p>#10</p>  <p>Counters 2PCS</p>
<p>#11</p>  <p>F4*1-1/2" Screws 4PCS</p>	<p>#12</p>  <p>Ball cups 2PCS</p>	<p>#13</p>  <p>8* 5/8" Screws 2PCS</p>	<p>#14</p>  <p>5/16**19mm Washers 4PCS</p>	<p>#15</p>  <p>Steel Sticks 2PCS</p>
<p>#16</p>  <p>5/16" Lock Hexnuts 4PCS</p>	<p>#17</p>  <p>Rod Handles 8PCS</p>	<p>#18</p>  <p>Rod End Caps 8PCS</p>	<p>#19</p>  <p>Bumpers 16PCS</p>	<p>#20</p>  <p>Plastic Washers 16PCS</p>
<p>#21</p>  <p>Bushings 4PCS</p>	<p>#22</p>  <p>Players 22PCS</p>	<p>#23</p>  <p>Nuts 26PCS</p>	<p>#24</p>  <p>8*1" Bolts 26PCS</p>	<p>#25</p>  <p>8*1-3/4" Screws 8PCS</p>
<p>#26</p>  <p>5-Man Rods 2PCS</p>	<p>#27</p>  <p>3-Man Rods 4PCS</p>	<p>#28</p>  <p>2-Man Rods 2PCS</p>	<p>#29</p>  <p>Soccer Balls 4PCS</p>	<p>#30</p>  <p>T4*1/2" Screws 10PCS</p>
<p>#31</p>  <p>Ball Collectors 2PCS</p>	<p>#32</p>  <p>Triangle Blocks 8PCS</p>	<p>#33</p>  <p>Wrench 1PC</p>	<p>#34</p>  <p>T4*3/4" Screws 8PCS</p>	<p>#35</p>  <p>Wrench 1PC</p>

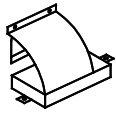
STEP 1

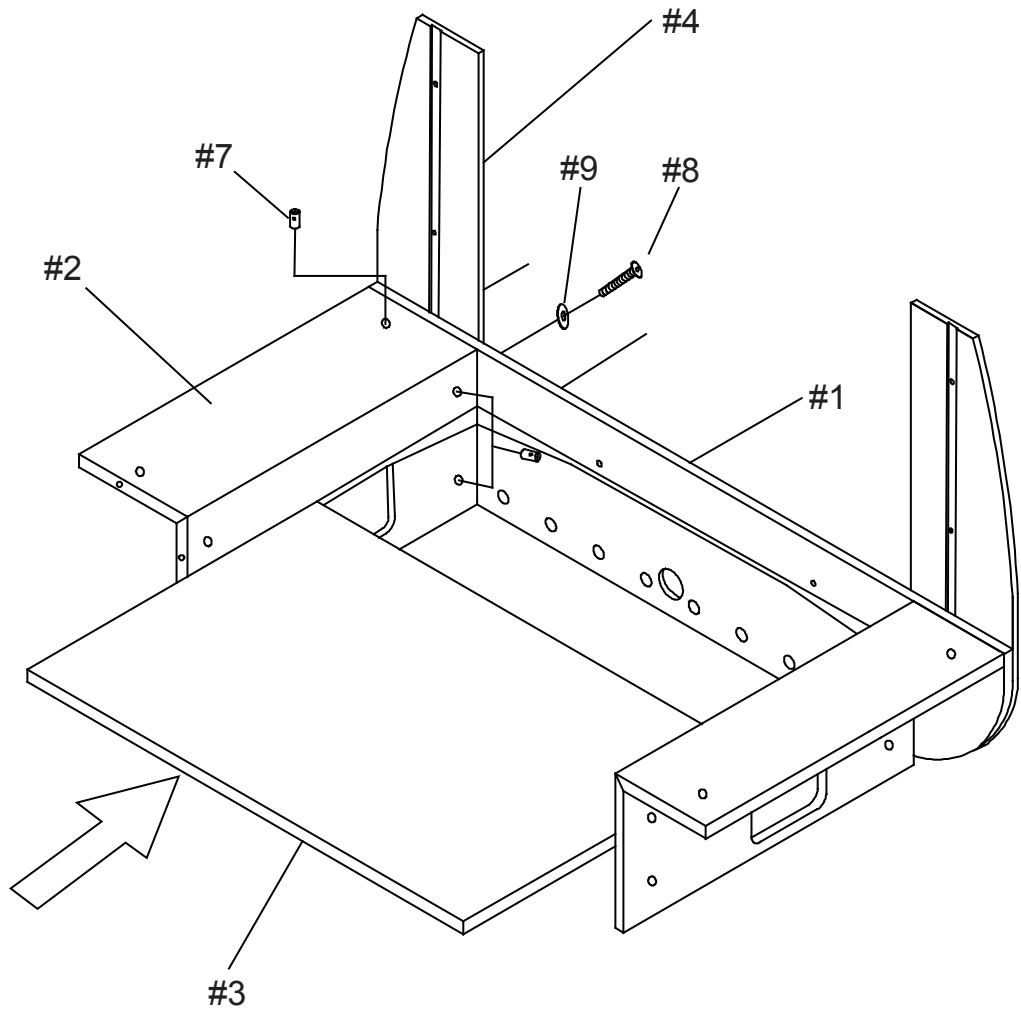

STEP 2

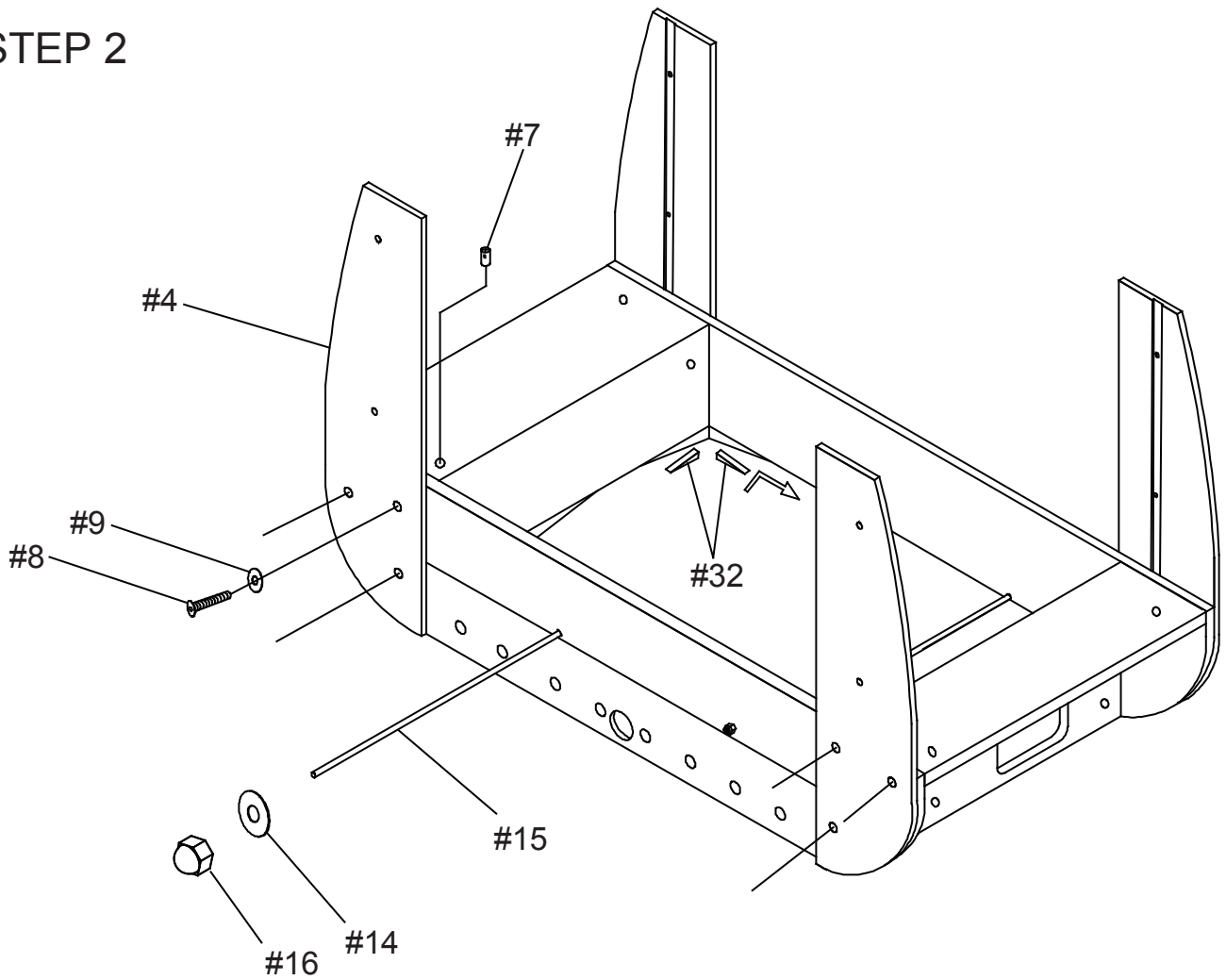

STEP 3

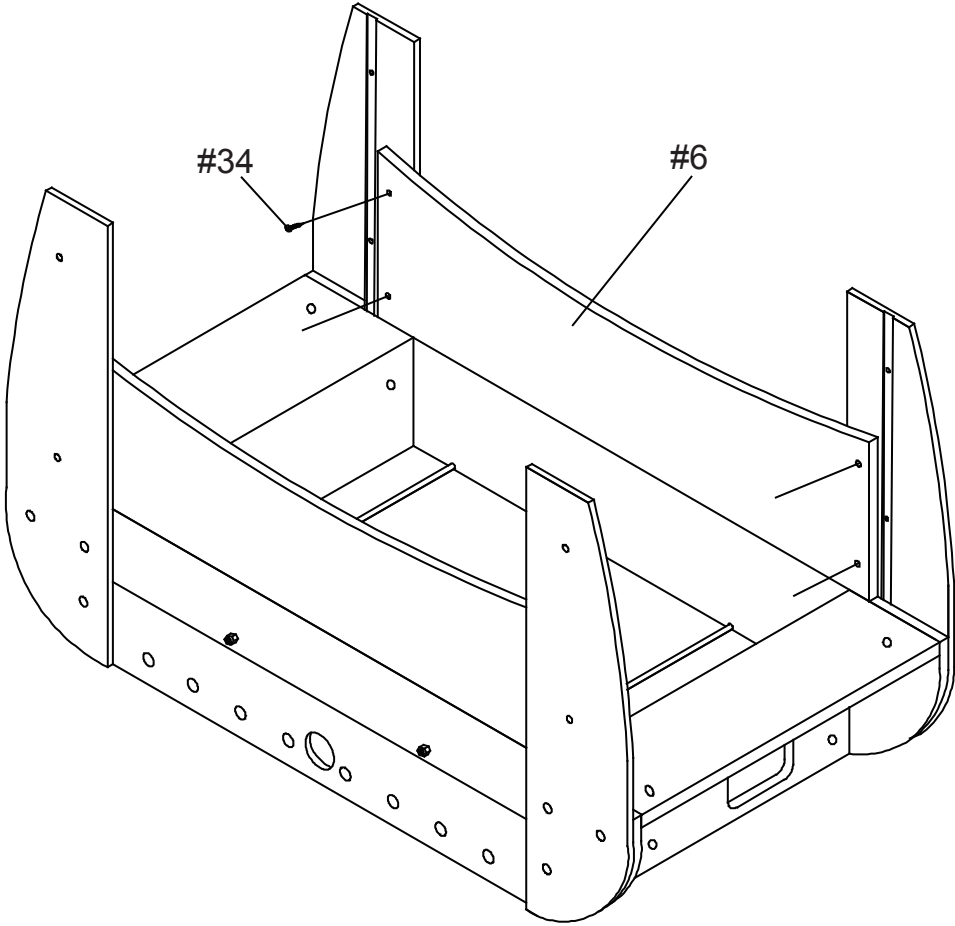

STEP 4

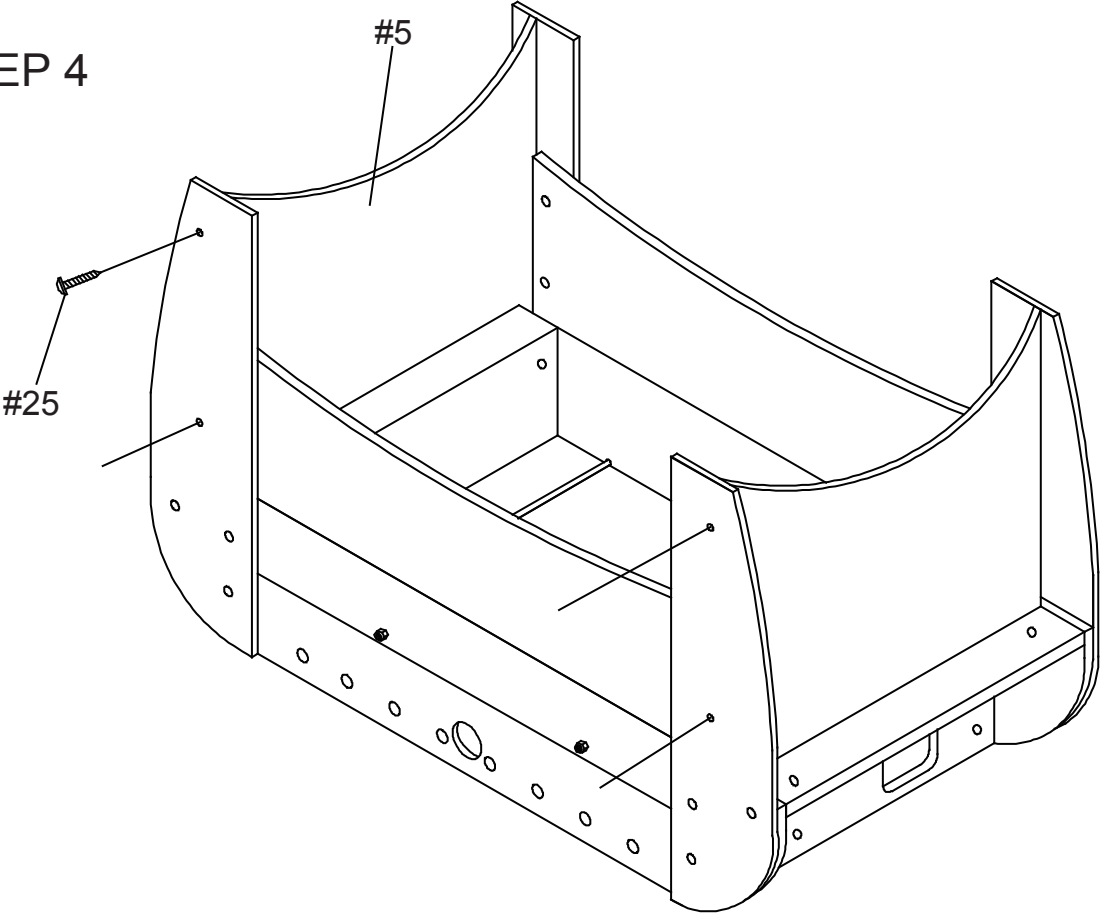

# STEP 5

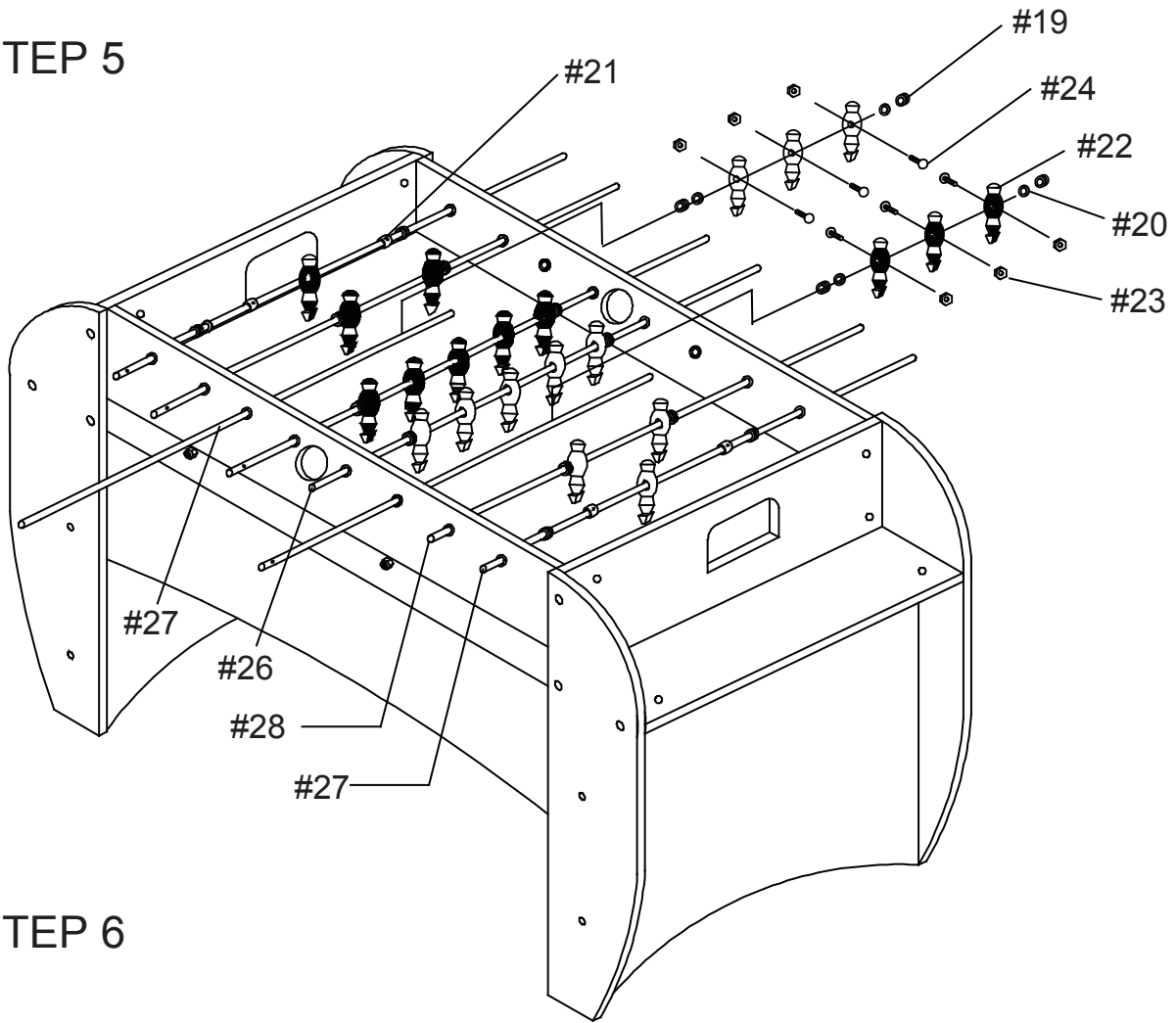

# STEP 6

